

MODERN  FLAMES

Spectrum Series Electric

SC36-B • SL50-B • SL74-B



INSTALLATION/SERVICE INSTRUCTIONS
CE RATED FOR 230V 50HZ INSTALLATIONS

MODERN FLAMES

SPECTRUM SERIES ELECTRIC SC36-B • SL50-B • SL74-B SAFETY INFORMATION AND OPERATIONS MANUAL



Read these instructions completely before beginning installation. Failure to follow them could cause a heater malfunction resulting in serious injury and/or property damage.

WARNING: All electric heaters have hot and arcing or sparking parts inside. Do not use it in areas where gasoline, paint or flammable liquids are or are stored.

This fireplace meets the construction and safety standards of H.U.D. for application in manufactured homes when installed according to these instructions.

INSTALLER: Leave this manual with the appliance.
CONSUMER: Retain this manual for future reference.

USER INSTRUCTIONS

TABLE OF CONTENTS

Important Instructions.....	3	Operation	8
Power Data	4	Service Parts.....	9
Product Guide	4	Troubleshooting	10
Box Contents.....	5	Frequently Asked Questions	11
Locating Fireplace.....	5	Cleaning and Maintenance Instructions	12
Unpacking and Testing.....	5	Wiring Diagram	12
Installation	6		

IMPORTANT INSTRUCTIONS

When using electrical heaters, basic precautions should always be followed to reduce the risk of fire, electric shock and injury to persons, including the following:

WARNING: Improper installation, adjustment, alteration, service or maintenance can cause injury or property damage. Refer to this manual. For assistance or additional information, consult a qualified installer.

CAUTION: Do not expose the heater to the elements (such as rain, etc).

Do not place clothing or other flammable material on or near firebox. Never place any objects on the fireplace.

Carefully supervise young children when they are in the room with fireplace.

Fireplace becomes very hot when running. Keep children and adults away from hot surfaces to avoid burns or clothing ignition. Fireplace will remain hot for a time after shutdown. Allow surfaces to cool before touching.



CAUTION: In order to avoid overheating, do not cover the heater.

1. Read all instructions before installing or using this heater.
2. This heater is hot when in use. To avoid burns, do not let bare skin touch hot surfaces. Keep combustible materials, such as furniture, pillows, bedding, papers, clothes, and curtains at least 3 feet (0.9m) from the front of the heater and keep them away from the sides and rear.
3. Extreme caution is necessary when any heater is used by or near children or disabled people and whenever the heater is left operating and unattended.
4. Do not operate any heater after it malfunctions, has been dropped, or damaged in any manner. Disconnect power at service panel and have heater inspected by an authorized technician or a reputable electrician before using.
5. Do not use outdoors.
6. To disconnect heater, turn controls to off and turn off power to heater circuit at main disconnect panel.
7. Do not insert or allow foreign objects to enter any ventilation or exhaust opening as this may cause an electric shock or fire, or damage the heater.
8. To prevent a possible fire, do not block air intakes or exhaust in any manner.
9. A heater has hot and arcing or sparking parts inside. Do not use it in areas where gasoline, paint or flammable vapors or liquids are used or stored.
10. Use this heater only as described in this manual. Any other use not recommended by the manufacturer may cause fire, electric shock or injury to persons.
11. This heater is not intended for use in bathrooms, laundry areas and similar indoor locations. Never locate heater where it may fall into a bathtub or other water container.
12. SAVE THESE INSTRUCTIONS

USER INSTRUCTIONS

POWER DATA

	SC36-B	SL50-B	SL74-B
Volts/HZ Amps	AC 230V/50Hz 7 Amps	AC 230V/50Hz 7 Amps	AC 230V/50Hz 7 Amps
Heater	AC 230V/50Hz .9kW/1.8kW	AC 230V/50Hz .9kW/1.8kW	AC 230V/50Hz .9kW/1.8kW
Lamps	LED 12V	LED 12V	LED 12V
Rotor motor	AC 230V/50Hz 4W CCW 15/18 r/min	AC 230V/50Hz 4W CCW 15/18 r/min	AC 230V/50Hz 4W CCW 15/18 r/min
Shipping Size	991mm x 241mm x 692mm	1321mm x 241mm x 546mm	1937mm x 241mm x 540mm

PRODUCT GUIDE

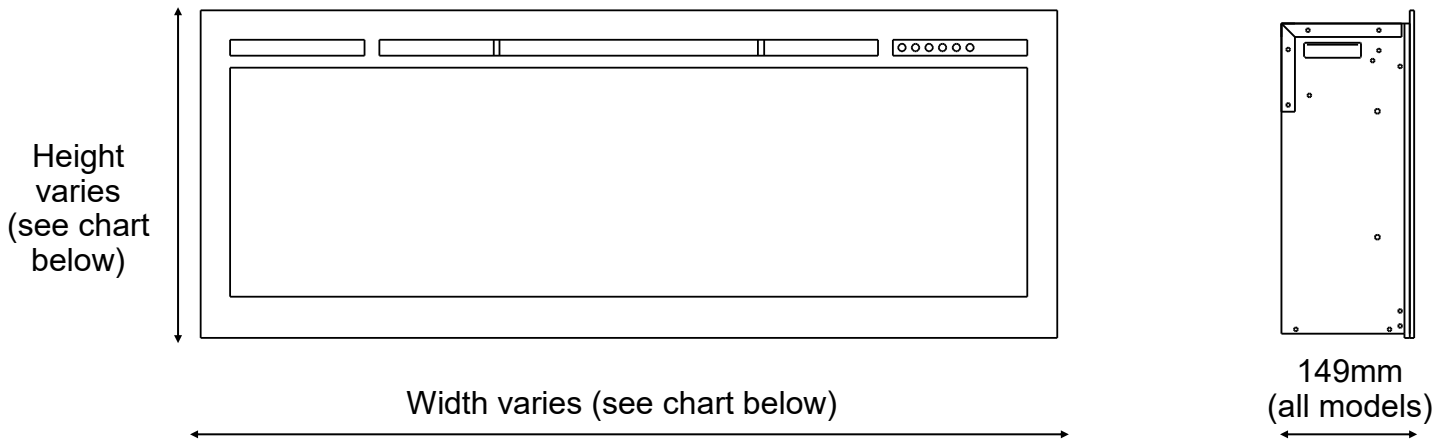

Model	Viewing Area	Firebox Dimensions	Framing Dimensions
SC36-B	845mm W x 483mm H	887mm W x 602mm H x 195mm D	902mm W x 610mm H x 203mm D
SL50-B	1175mm W x 338mm H	1217mm W x 457mm H x 195mm D	1232mm W x 464mm H x 203mm D
SL74-B	1792mm W x 338mm H	1834mm W x 457mm H x 195mm D	1848mm W x 464mm H x 203mm D

INSTALLATION

BOX CONTENTS

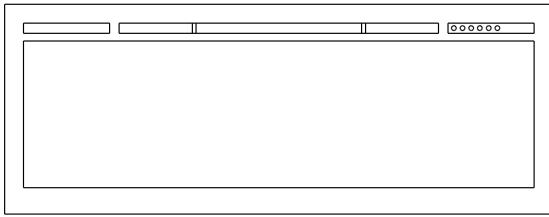

1 Fire Unit



4 Large Washer Head Screws



4 Screw Covers



2 Boxes of Glacier Crystal—Clear & Smoke

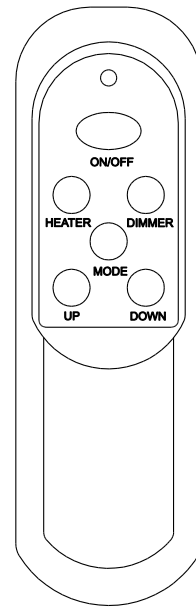

1 Remote

LOCATING FIREPLACE

CAUTION: Do not locate in a moist room such as a bathroom or laundry room.

CAUTION: Wear gloves and safety glasses for protection during installation and maintenance.

UNPACKING AND TESTING

Carefully remove unit from box. Prior to permanently installing unit, test to make sure unit operates properly. To do this, plug unit's power supply cord into a conveniently located 230-volt grounded outlet.

WARNING: Do not operate the unit if it is damaged or has malfunctioned. If you suspect the unit is damaged, return the unit to an authorized service facility for examination, electrical or mechanical adjustment or repair.

CAUTION: The unit's power supply cord must be connected to a properly grounded and protected 230-volt outlet. Always use ground fault protection where required by the electrical code. Never use an extension cord with this product.

INSTALLATION

WARNING: If the information in these instructions is not followed exactly, a fire or explosion may result causing property damage, personal injury or death.

WARNING - RISK OF FIRE!

To prevent a possible fire, do not block air intake or exhaust in any manner. Do not use on soft surfaces where openings may become blocked.

WARNING - RISK OF FIRE!

Do not blow or place insulation against the firebox.

To reduce the risk of fire do not store or use gasoline or other flammable vapors in the vicinity of this or any other heater.

CAUTION: Keep combustible materials, such as furniture, pillows, bedding, papers, clothes and curtains at least 3 feet (0.9m) from the front of the heater and keep them away from the sides and rear.

Installing fireplace

Select a suitable location that is not susceptible to moisture and is a safe distance from drapes, furniture and high traffic areas. A qualified electrician should add an electrical outlet per local building codes. See shaded area on installation diagram below for proper outlet placement.

Note: Follow all national and local electrical codes. This fireplace can be framed in to the wall.

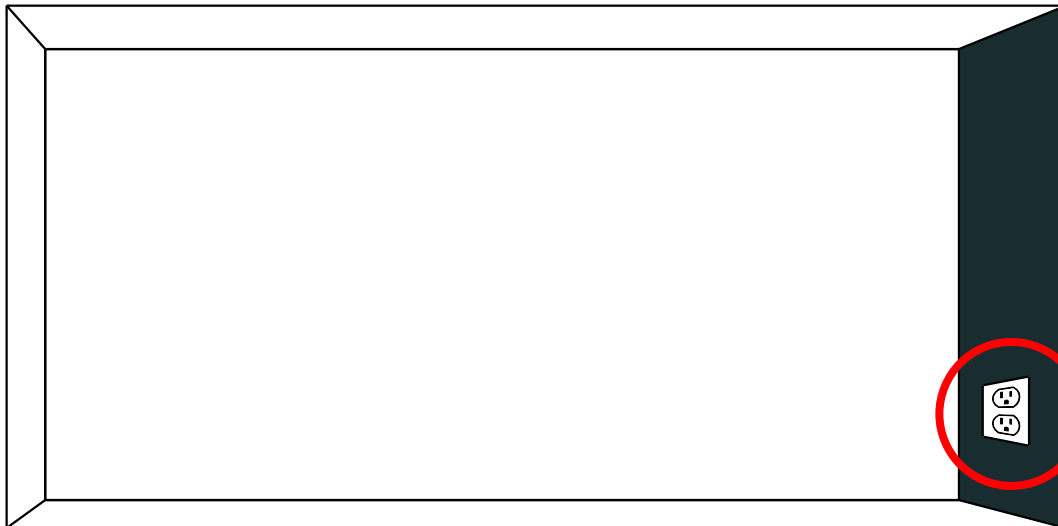

Electrician should add a 230v outlet to the rear portion of the right side of the framed opening (see the shaded panel.)

INSTALLATION

Model	H	W	D
SC36-B	610mm	902mm	203mm
SL50-B	464mm	1232mm	203mm
SL74-B	464mm	1848mm	203mm

Hard wire location lower right corner of framed opening.

1. Prepare the framed opening according to the chart above.

Electrician should add a 230v outlet to the rear portion of the right side of the framed opening.

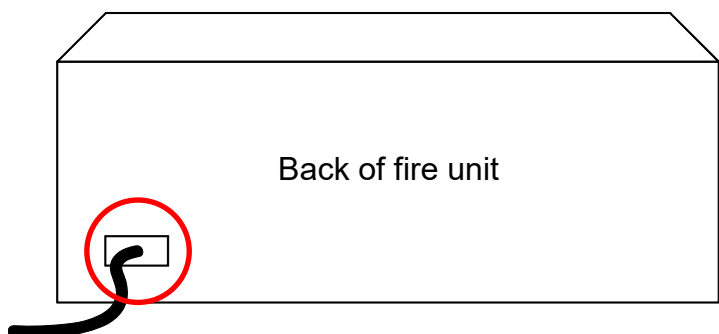
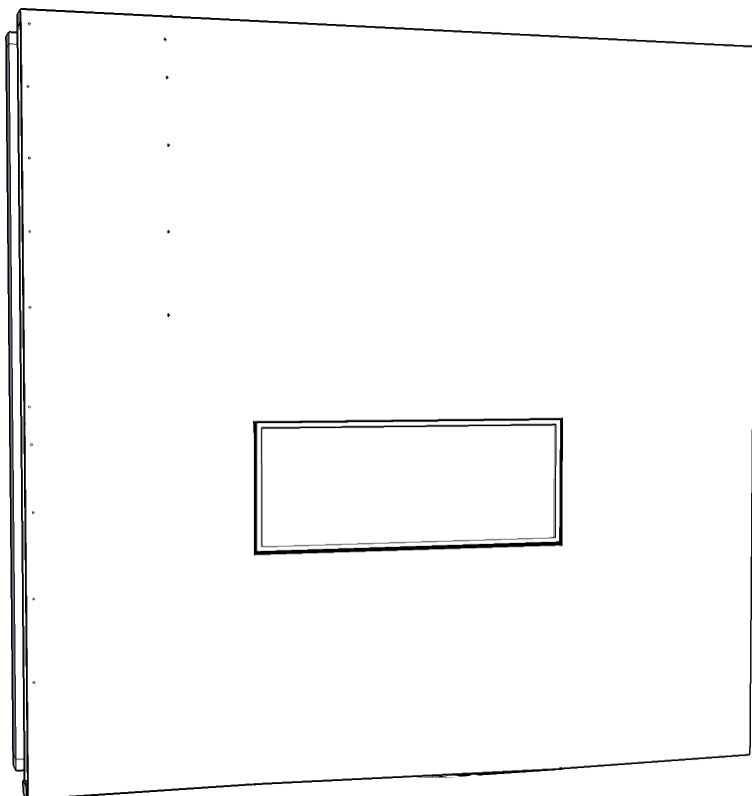

Back of fire unit

To be performed by a qualified electrician according to local building codes.

2. Plug the fire unit in to the provided outlet.

3. Lift to remove the glass face of the fire place and carefully set to the side. Slide the unit in to the framed opening until it is flush with the wall or at the dry wall stops. The fire unit has 2 holes each on the left and right side to secure to the frame. Use the provided screws and screw covers.

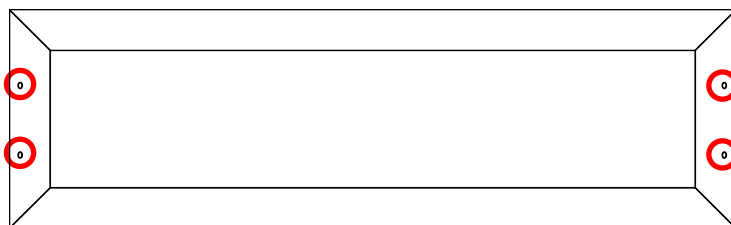

4. Replace the glass face on the fire unit.

OPERATION

The unit has no main power switch. **(Caution: If servicing this unit, turn off power at the main circuit breaker or unplug the unit.)**



Press the On/Off button once to turn the unit on. Press the On/Off button a second time to turn the unit off.



Press the Heater button to turn the heater to low. Press the Heater button a second time to turn the heater to high. Pressing the Heater button a third time turns the heater off.

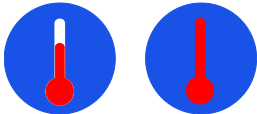

To set the digital thermostat, touch the temperature down thermometer to lower the temperature set point. Press the temperature up thermometer to raise the temperature set point. The set point will be indicated on the digital display. To change from Fahrenheit to Celsius hold both the temperature down and temperature up button at the same time until the setting changes.



Press the Color Mode button to toggle the unit through the available colors. Colors are also indicated by the numerical reference in the digital display.



Press the Dimmer button to dim the fire image. Pressing the Dimmer button multiple times will cycle through the available brightness settings.

Press the On/Off button once to turn the unit on. Press the On/Off button a second time to turn the unit off.

Press the Heater button to turn the heater to low. Press the heater button a second time to turn the heater to high. Pressing the Heater button a third time turns the heater off.

To set the digital thermostat, touch the temperature down thermometer to lower the temperature set point. Press the temperature up thermometer to raise the temperature set point. The set point will be indicated on the digital display.

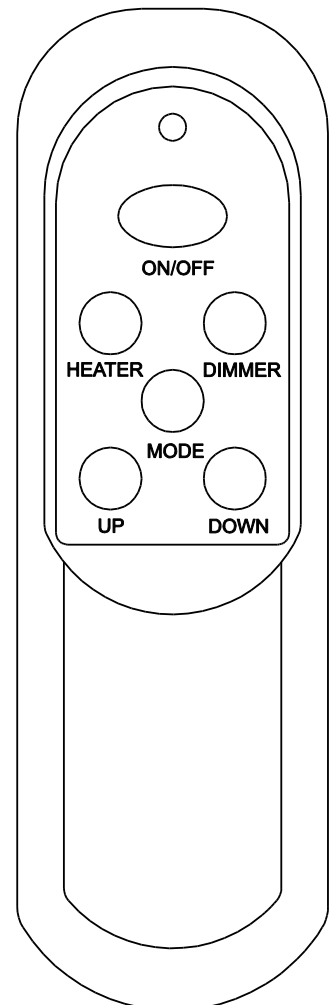

Press the Color Mode button to toggle the unit through the available colors. Colors are also indicated by the numerical reference in the digital display.

Press the Dimmer button to dim the fire image. Pressing the Dimmer button multiple times will cycle through the available brightness settings.

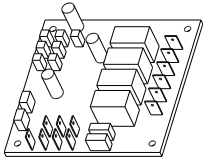
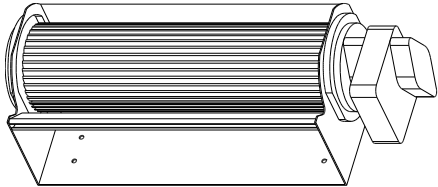
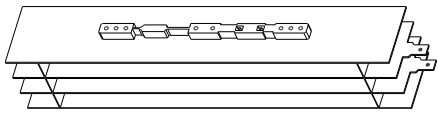
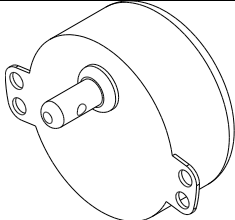
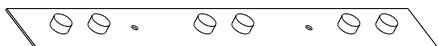

MAINTENANCE

SPECTRUM SERVICE PARTS

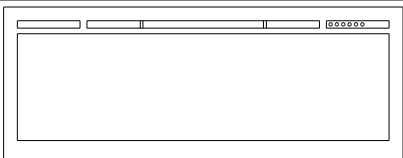
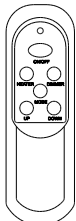
ITEM	PHOTO	COMMENTS
SPEC-PCB1		PRINTED CIRCUIT BOARD SPEC 36 & 50
SPEC-PCB2		PRINTED CIRCUIT BOARD SPEC 74
SPEC-BLOWER		HEATER FAN 230 V 1.5kW
SPEC-HEATER		HEATER 230 V .75 kW
SPEC-MOTOR		SPINDLE MOTOR 230 V 50 HZ
SPEC-36-LED-F		FLAME LED SPEC 36
SPEC-50-LED-F		FLAME LED SPEC 50
SPEC-74-LED-F		FLAME LED SPEC 74
SPEC-36-LED-M		MEDIA LED SPEC 36
SPEC-50-LED-M		MEDIA LED SPEC 50
SPEC-74-LED-M		MEDIA LED SPEC 74
FACE-B 36		GLASS FACE WITH METAL TRIM
FACE-B 50		GLASS FACE WITH METAL TRIM
FACE-B 74		GLASS FACE WITH METAL TRIM
SPEC-RC		REMOTE CONTROL

TROUBLESHOOTING

PROBLEM	POSSIBLE CAUSE	CORRECTIVE ACTION
Nothing comes on (touch screen, etc.)	A. Breaker tripped or circuit has no power	A. Reset breaker, test circuit for power
	B. Internal component is frozen and needs to be reset	B. Turn power off at the main breaker for 20 seconds. Turn power back on.
	C. Defective component	C. Qualified service technician needs to replace motherboard, transformer or LCD touch control
Touch Screen Comes on - then nothing	A. Fireplace is not plum to the wall (there is space between the touch screen and fascia)	A. Reposition the fireplace in the installation so the glass fascia rests firmly to the fireplace touch controls. Check that fascia is seated correctly on pins
	C. Not operating touch control properly with finger	C. Press flat part of finger firmly on the touch screen and apply moderate pressure
	D. Loose connection on motherboard	D. Check functions with remote control. if functional, check connections on motherboard
	E. Motherboard is defective	E. Replace Motherboard
	A. Fireplace has overheated and safety disc has snapped or circuit breaker has tripped	A. Turn the main breaker to the "off" position for 30 seconds. Next flip the breaker back into the "on" position.
Fireplace turns off and will not turn back on	A. Low Batteries	A. Replace batteries in remote control with 2 AA batteries
	B. Not aiming control correctly	B. Aim remote control to the upper right of the viewing area where sensor is located
	C. Remote control defective	C. Replace remote control
	D. Remote Sensor is defective	D. Replace remote sensor inside fireplace
Can operate fireplace functions with touch controls but not remote control	A. Low Batteries	A. Replace batteries in remote control with 2 AA batteries
	B. Not aiming control correctly	B. Aim remote control to the upper right of the viewing area where sensor is located
	C. Remote control defective	C. Replace remote control
	D. Remote Sensor is defective	D. Replace remote sensor inside fireplace

MAINTENANCE

PROBLEM	POSSIBLE CAUSE	CORRECTIVE ACTION
Flame is not visible when unit is turned on	A. Wiring is loose	A. Disconnect unit from power source and inspect for loose connections
	B. Motherboard is defective	B. Replace motherboard
Fireplace lights up but there is no flame image	A. Wiring for motor is loose	A. Disconnect unit from power source and inspect for loose connections from motor
	B. Motor is defective	B. Replace motor
Fireplace is squeaking when flame image is on	A. Fireplace spindle/ rod is contacting to metal	A. Apply lithium grease or any standard grease to contacts with rod and metal
	B. Motor is defective	B. Replace motor
Heater does not provide heat when on	A. Wiring is loose	A. Disconnect unit from power source and inspect for loose connections
	B. Thermal snap disc has been tripped	B. Turn the main breaker to the "off" position for 30 seconds. Next flip the breaker back into the "on" position.
	C. Heater core is defective	C. Replace Heater Core

FREQUENTLY ASKED QUESTIONS

Q. How do you program the remote control?

A. The remote comes pre-programmed. No programming is necessary.

Q. What distance can the remote be used from the fireplace?

A. Optimal distance for the remote control is within 6 meters.

Q. Can you turn on the fireplace via the touch screen and off via the remote (or vice versa)?

A. Yes.

Q. Can the fireplace be installed outside?

A. No. Please review the entire safety chapter before installing this fireplace.

Q. Does the fireplace need to be on a dedicated 10 amp circuit?

A. Yes.

Q. How often do the batteries in the remote need to be replaced?

A. Annually, possibly more with heavy use.

Q. Is there a remote receiver in the fireplace that requires batteries?

A. No, only the actual remote requires batteries. The rest of the fireplace runs entirely off of the main power supply.

Q. How do you change the temperature setting from Fahrenheit to Celsius (or vice versa)?

A. Hold both the temperature down and temperature up button at the same time until the setting changes.

CLEANING AND MAINTENANCE INSTRUCTIONS

There is very little maintenance involved with your electric fireplace. Please follow the few points below:

- On a semi-annual basis unplug the machine from it's power source and wait for the heating element to cool, remove the glass face of the fireplace and dust the fire unit with a dry cloth. Be careful not to brush any wires that may be exposed as you do this.
- To clean the glass face of the fireplace simply use your desired glass cleaner with paper towels.
- To clean the air inlets/outlets, wipe with a soft cloth or the nozzle of a vacuum cleaner
- Dust can easily build up around the heater. Vacuum or brush away any loose dust. Take particular care to clean this area on a regular basis to prevent buildup.

WIRING DIAGRAM

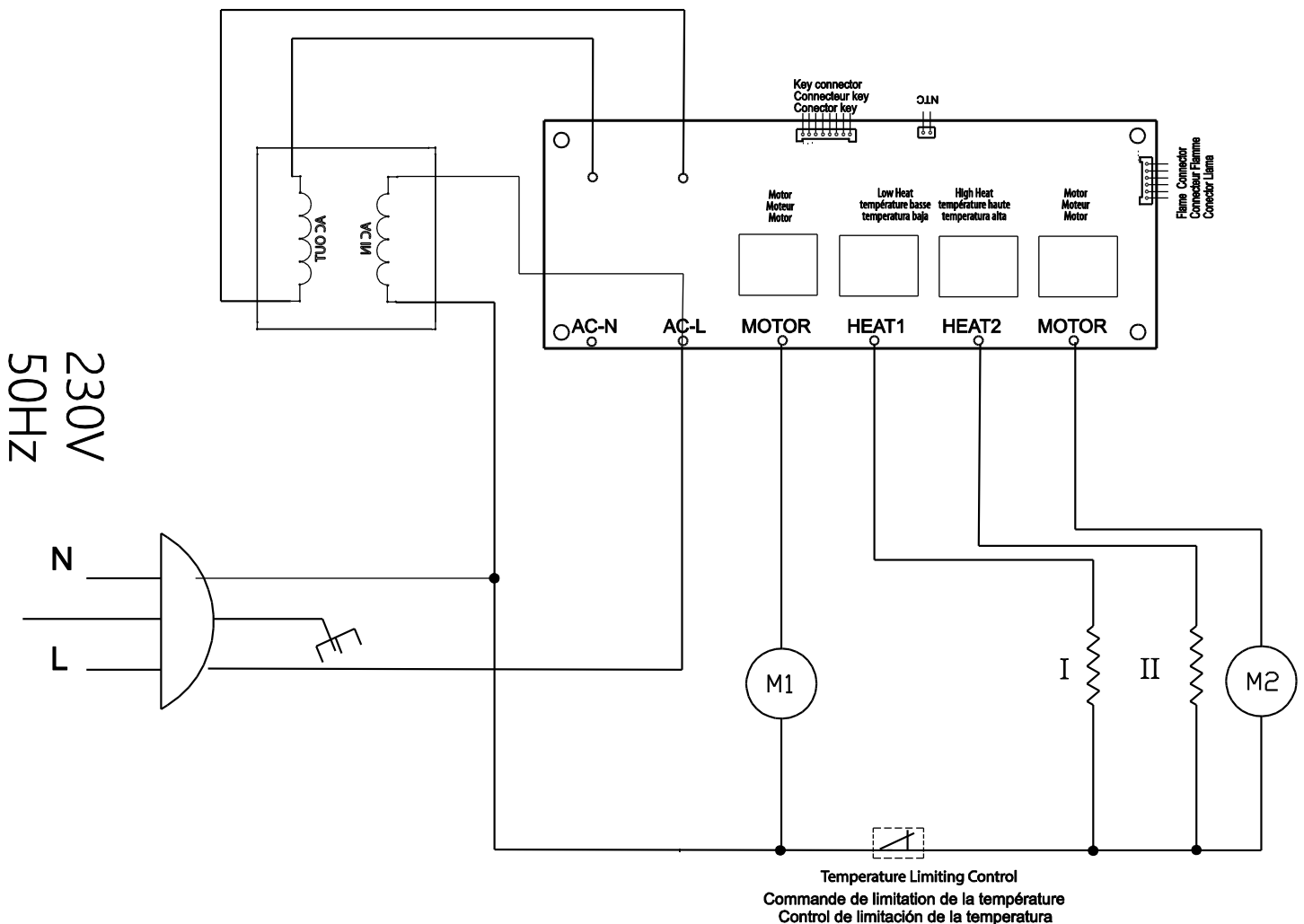

© 2013-2015

MODERN  FLAMES

www.modernflames.com
Please dispose of properly.



Ver. 4