

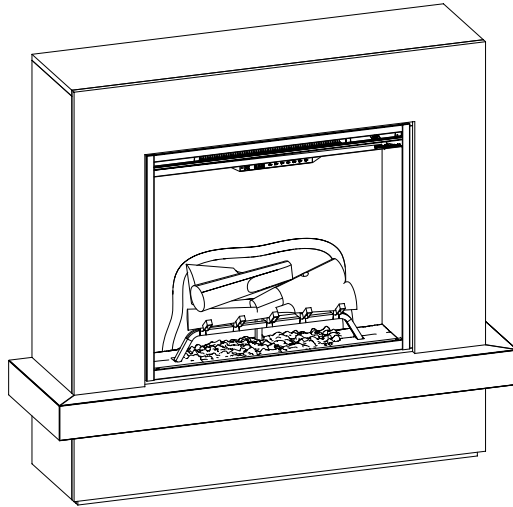

Owner's Manual



Revillusion™ Suites





Sherwood Revillusion Suite

SWD20-AU

IMPORTANT SAFETY INFORMATION: Read this manual first before attempting to install or use the Revillusion™ Built-in Electric Firebox. Always comply with the warnings and safety instructions contained in this manual to prevent personal injury or property damage.

8/54150/0 (AU/NZ) Issue 1

Table of Contents

 Welcome	3
 IMPORTANT INSTRUCTIONS	4
 Setup & Product Dims.....	6
 Operation.....	8
 Maintenance.....	11

SAVE THESE INSTRUCTIONS

Conventions used in this manual:

! NOTE: Procedures and techniques considered important enough to emphasize.

⚠ CAUTION: Procedures and techniques which, if not carefully followed, will result in damage to the equipment.

⚠ WARNING: Procedures, precautions and techniques which, if not carefully followed, will expose the user to the risk of fire, serious injury, or death.

Welcome

Thank you for purchasing a Revillusion™ Built-in Electric Firebox by Dimplex.

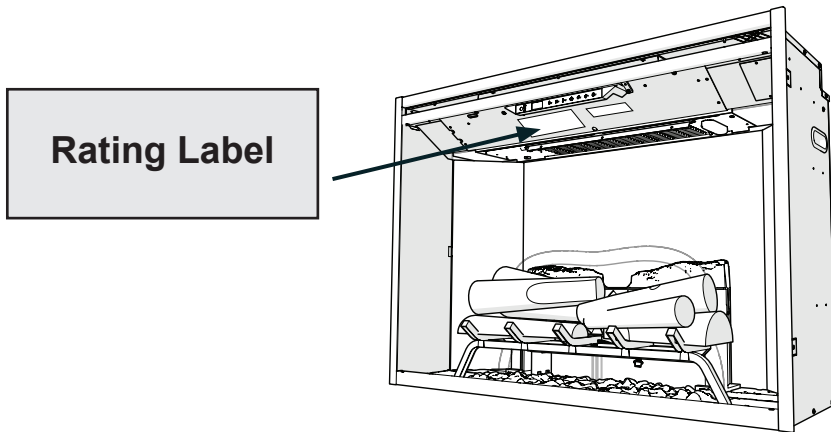

⚠ CAUTION: Read all instructions and warnings carefully before starting installation. Failure to follow these instructions may result in a possible electric shock or fire hazard and will void the warranty.



NO NEED TO RETURN TO THE STORE

Questions with operation or assembly? Require Parts Information?
Product Under Manufacturer's Warranty?

Please consult your warranty card for our contact details.

IMPORTANT INSTRUCTIONS

Read all instructions before using this appliance.



When using electrical appliances, basic precautions should always be followed to reduce the risk of fire, electrical shock and injury to persons, including the following:

1. If the appliance is damaged, check with the supplier before installation and operation.
2. Do not use outdoors.
3. Do not use in the immediate surroundings of a bath, shower or swimming pool.
4. Do not locate the appliance immediately below a fixed socket outlet or connection box.
5. This appliance can be used by children aged from 8 years and above and persons with reduced physical, sensory or mental capabilities or lack of experience and knowledge if they have been given supervision or instruction concerning use of the appliance in a safe way and understand the hazards involved. Children shall not play with the appliance. Cleaning and user maintenance shall not be made by Children without supervision.
6. Children of less than 3 years should be kept away unless continuously supervised. Children aged from 3 years and less than 8 years shall only switch on/off the appliance provided that it has been placed or installed in its intended normal operating position and they have been given supervision or instruction concerning use of the appliance in a safe way and understanding the hazards involved. Children aged from 3 years and less than 8 years shall not plug in, regulate and clean the appliance or perform user maintenance.
7. Do not use this appliance in series with a thermal control, a program controller, a timer or any other device that switches on the heat automatically, since a fire risk exists when the appliance is accidentally covered or displaced.
8. Ensure that furniture, curtains or other combustible material are positioned no closer than 1 metre from the appliance.
9. In the event of a fault unplug the appliance.
10. Unplug the appliance when not required for long periods.
11. Although this appliance complies with safety standards, we do not recommend its use on deep pile carpets or on long hair type of rugs.
12. The appliance must be positioned so that the plug is accessible.
13. If the supply cord is damaged it must be replaced by the manufacturer or service agent or a similarly qualified person in order to avoid a hazard.
14. Keep the supply cord away from the front of the appliance.

IMPORTANT INSTRUCTIONS

 **WARNING:** In order to avoid overheating, do not cover the appliance. Do not place material or garments on the appliance, or obstruct the air circulation around the appliance, for instance by curtains or furniture, as this could cause overheating and a fire risk.

 **WARNING:** In order to avoid a hazard due to inadvertent resetting of the thermal cut-out, this appliance must not be supplied through an external switching device, such as a timer, or connected to a circuit that is regularly switched on and off by the utility.

 **CAUTION:** Some parts of this product can become very hot and cause burns. Particular attention has to be given where  children and vulnerable people are present.

 **WARNING: KEEP BATTERIES OUT OF REACH OF CHILDREN**

 1. Swallowing may lead to serious injury in as little as 2 hours or death, due to the chemical burns and potential perforation of the oesophagus.

2. If you suspect your child has swallowed or inserted a button battery immediately call the 24-hour Poisons Information Centre on 13 11 26 (in Australia) or 0800 764 766 (in New Zealand) for fast, expert advice.

3. Examine devices and make sure the battery compartment is correctly secured, e.g. that the screw or other mechanical fastener is tightened. Do not use if the compartment is not secure.

4. Dispose of used button batteries immediately and safely. flat batteries can still be dangerous.

Setup & Product Dims

Operation Temperature

-4° to 104° F (-20° to 40° C)

Fixed Wiring

In some jurisdictions this appliance is supplied without a plug this is to comply with the local regulations. In such instances this appliance must be installed by a suitably qualified installer and the means for disconnection must be incorporated in the fixed wiring in accordance with the local wiring rules.

 **WARNING:** Electrical outlet wiring must comply with local building codes and other applicable regulations to reduce the risk of fire, electric shock, or injury to persons.

! NOTE: A 13Amp (EU) or 10 Amp(AU/NZ) circuit is required. A dedicated circuit is preferred, but not essential in all cases. A dedicated circuit will be required if, after installation, the circuit breaker trips or the fuse blows on a regular basis when the heater is operating. Additional appliances on the same circuit may exceed the current rating of the circuit breaker.

Unpacking the Unit

The unit comes packed with a protective sheet covering the front of the unit. This sheet is intended to prevent dust and debris from entering during construction. This sheet is designed so that it can be partially removed to complete the wiring and unpacking and can be reinstalled until the final installation is complete.

The log set was installed on the grate and the grate permanently fixed to the firebox at the factory.

Carefully remove the packaging from around the log set. Make sure the wires from the log set are connected securely to the grate box.

 **CAUTION:** The Realogs™ contain LEDs to create a unique pulse and glow effect. Handle the log set carefully. They are fragile and can crack or break if dropped.

Fitting

 **WARNING: FALLING OR TIPPING APPLIANCES CAN CAUSE INJURY OR DEATH OF YOUNG CHILDREN, PLEASE ENSURE CHILDREN DO NOT CLIMB, HANG OR STAND ON THIS PRODUCT.**

 **WARNING: THE APPLIANCE IS PROVIDED WITH A TIPPING RESTRAINT, THIS RESTRAINT IS NOT A SUBSTITUTE FOR PROPER ADULT SUPERVISION. THIS RESTRAINT MAY PROVIDE PROTECTION AGAINST TIPPING FURNITURE. DO NOT ALLOW CHILDREN TO CLIMB ON FURNITURE. FAILURE TO DETACH THIS RESTRAINT BEFORE MOVING FURNITURE MAY RESULT IN INJURY AND DAMAGE.**

This product is provided with a 'Tipping Restraint Kit' as shown below, to prevent the product accidentally tipping over. Fitting Instructions are supplied with this kit please follow these instructions carefully.

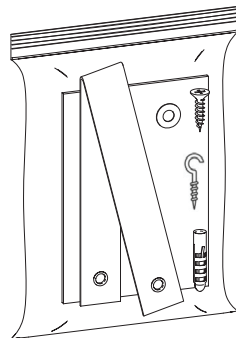

Setup & Product Dims

Sherwood

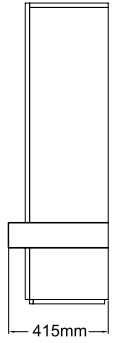
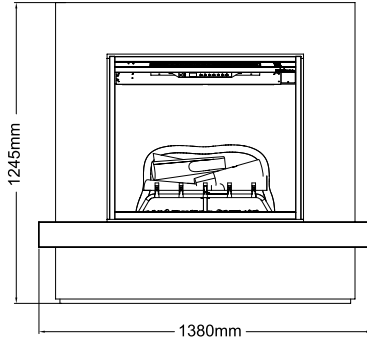
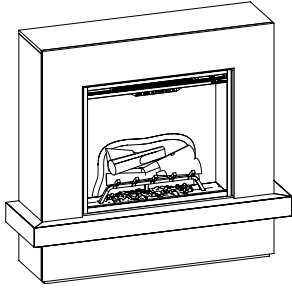

🔑 Operation

Touch Panel and Remote Controls

⚠️ WARNING: The Revillusion™ Built-in Electric Firebox must be installed properly before it is used.







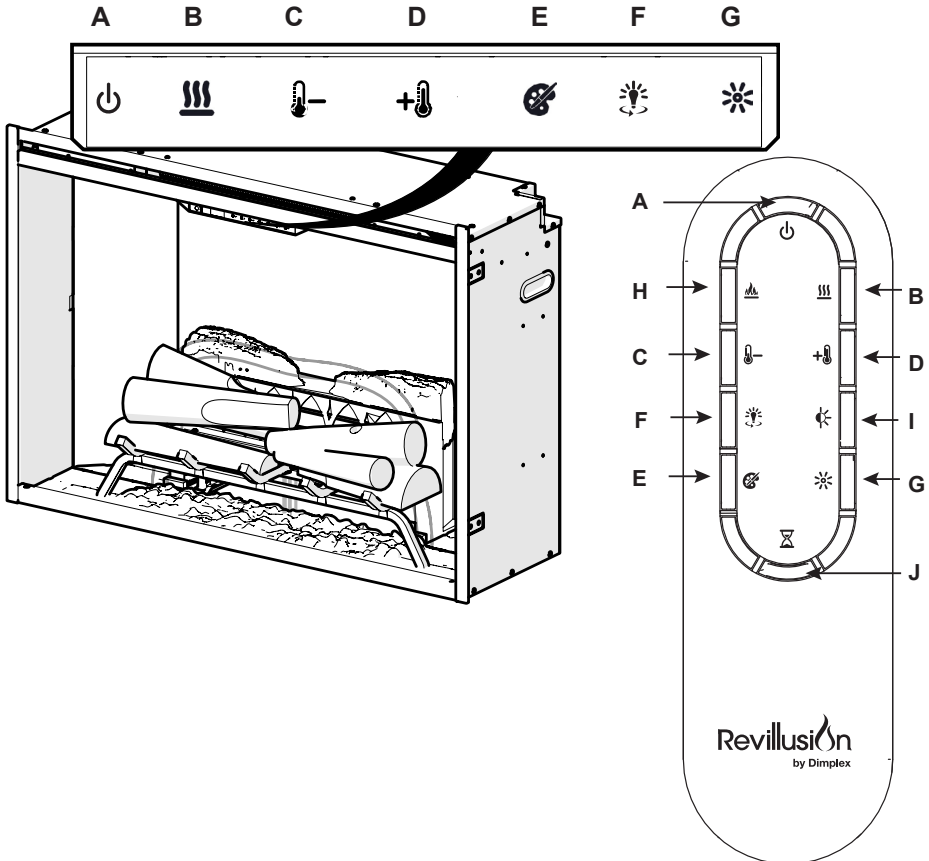



⚠️ CAUTION: Except for installation and cleaning described in this manual, an authorized service representative should perform any other servicing.

The manual controls for the Revillusion™ Built-in Electric Firebox are located on the front panel. Touch an icon to activate. The selected setting displays on the left side of the panel.











A multi-function remote control also is provided. The remote control has a range of approximately 30 ft (9 m). To operate correctly, the remote control must be pointed toward the front of the built-in electric firebox.



Operation

	Icon	Function	Description
A		Power/ Standby	<p>Press to activate the current standby state (On/Off).</p> <ul style="list-style-type: none"> • Standby State On Press to turn everything Off. Press again to activate the previous state. • Standby State Off Press to activate the previous state. <ul style="list-style-type: none"> - If the flame effect was On, the previous heat setting will be activated (On or Off). - If the flame effect was Off, the previous heat setting will be activated (High or Low). <p>Press again to turn everything Off.</p>
B		Heat	<ul style="list-style-type: none"> • Heat On Press to turn heat On (indicated by 1 short beep and the icon appearing on the display). Displays current heater temperature setting. Use the Temp Up/Down icon to change the heater temperature setting. • Heat Off Press to turn heat Off (indicated by 1 short beep). <p>! NOTE: After the heater is switched off, the fan will continue on for 60 seconds before turning off.</p>
C		Temp Down	Press multiple times to lower the heater temperature in 1° F (1° C) increments. Displays current temperature; lowest temperature is 41° F (5° C). This feature is active whenever the heat is enabled.
D		Temp Up	Press multiple time to raise the heater temperature in 1° F (1° C) increments. Displays current temperature; highest temperature is 99° F (37° C). This feature is active whenever the heat is enabled.
Change Fahrenheit (° F) to Celsius (° C)			Press both Temp+ () and Temp– () on the unit.
Heat Enable			Hold both Heat () and Temp– (), on the unit, for 2 seconds. Temperature displays on the screen.
Heat Disable			Hold both Heat () and Temp– (), on the unit, for 2 seconds, when temperature is adjusted "---" displays on the screen.

Operation

	Icon	Function	Description
E		Color Themes	Press multiple times to change the flame base colors from Red to Blue to Off. (The first segment on the display will change from "r" to "b" to blank) This feature is active only when the flame effect is On.
F		360° Light	Press multiple times to change the LEDs on the sides and back of the unit from Midnight mode to white to yellow to red. (The middle segment on the display will change through 0 - 3 respectively. This feature is active only when the Flame is ON.)
G		Brightness	Press to change the LED lights from High to Low. (The last segment on the display will change from "H" to "L") The Realog™ LEDs remain On when the heater is ON and the flame effect is Off. ! NOTE: When the Light Sensor is activated, High and Low flickering brightness settings are also available (Flashing "H" and "L").
H		Flame	Press to light the log set and start the flame effect. Press again to turn feature Off.
I		Light Sensor	Press to activate (ALS ON) the ambient light sensor. Press again to turn the sensor off (ALS OFF). ! NOTE: The light sensor will adjust the brightness of the fireplace based on the ambient light in the room.
J		Timer	Press multiple times to change the sleeper timer in 0.5 hr increments from 0.5 hr to 8.0 hr before turning off. The remaining time on the sleep timer displays.
		Control Lock	Hold both Temp- () and Brightness (), on the unit, for 2 seconds to disable the manual controls.
		Control Unlock	Hold both Temp- () and Brightness (), on the unit, for 2 seconds to enable the manual controls.

Resetting the Temperature Cutoff Switch

Should the heater overheat, an automatic cut out will turn the heater off and it will not come back on without being reset. It can be reset by disconnecting power at the main electrical panel and waiting 5 minutes before plugging the unit back in.

⚠ CAUTION: If you need to continuously reset the heater, unplug the unit and call technical support.



Maintenance

General Maintenance

Inspect the built-in electric firebox regularly, depending upon conditions, and at a minimum yearly intervals. Remove dust and clean the logs, grate, and base as required.

⚠ WARNING: Disconnect power and allow heater to cool before attempting any maintenance or cleaning to reduce the risk of fire, electric shock, or injury.

⚠ CAUTION: Except for installation and cleaning described in this manual, an authorized service representative should perform any other servicing.

Clean Logs and Base

The built-in electric firebox set should not be operated with an accumulation of dust or dirt on or in the firebox, as this can cause a build up of heat and eventual damage.

Dust and vacuum the firebox as needed. Use a damp cloth and a mild detergent to clean painted surfaces of the built-in electric firebox. Never use abrasive cleaners.

Clean Reflector Screen

The reflector screen is cleaned in the factory during the assembly operation. During shipment, installation, handling, etc., the screen may collect dust particles; these can be removed by dusting lightly with a clean dry cloth.

To remove fingerprints or other marks, clean the reflector screen damp cloth. Never use abrasive cleaners. Dry the screen completely with a lint free cloth to prevent water spots.

Remote Battery Replacement

To replace the battery:

1. Push down on the battery cover located on the back of the remote control. Slide the battery cover open.
2. Install 3V (CR2032) Lithium battery in the battery holder. The positive (+) side of the battery faces up.
3. Close the battery cover.



The old battery must be recycled or disposed of properly. Check with your Local Authority or Retailer for recycling advice in your area.

⚠ CAUTION: When transporting or storing the heater and cord, keep in a dry place, free from excessive vibration and store so as to avoid damage.